



140-280 HP | **MF 7700 S**



**FROM MASSEY FERGUSON**

# Contents



**Page 04**  
MF 7700 S - Born to Farm



**Page 08**  
The Smart Generation  
of Cost Effective Power



**Page 10**  
The Dyna transmissions



**Page 16**  
Welcome to your 'Farm office'



**Page 24**  
Operate your loader the  
Massey Ferguson way



**Page 26**  
Versatility means optimised costs



**Page 30**  
Hydraulic energy to power the  
most demanding task

- 03 Centre of Engineering and Manufacturing Excellence
- 04 MF 7700 S - Born to Farm
- 06 MF 7700 S - Bodyscan your new profit centre
- 08 The Smart Generation of Cost Effective Power
- 10 The Dyna transmissions
- 12 Dyna-4 - four-speed flexibility
- 13 Dyna-6 - performance, refined
- 14 Dyna-VT - the tractor transmission without limits
- 16 Welcome to your 'Farm Office'
- 18 Essential - The new standard for straightforward operation
- 20 Efficient - Advanced equipment to heighten your efficiency at work
- 22 Exclusive Package - The ultimate expression of productivity and innovation
- 24 Operate your loader the Massey Ferguson way
- 26 Versatility means optimised costs
- 28 Best in class manoeuvrability
- 30 Hydraulic energy to power the most demanding task
- 32 Outstanding operation and performance to tackle any task
- 33 AGCO Fuse™ Technologies: Connected Farming from Massey Ferguson
- 34 Fieldstar 5 - The new touch of Precision Farming
- 36 Guidance options to keep you on track for profit
- 38 AgControl™
- 39 TaskDoc™
- 40 Datatronic 4 console. Keeping you informed and in control
- 41 AgCommand® puts your finger on the pulse at all time
- 42 Servicing made easy
- 43 MF Services
- 44 Standard and optional equipment
- 46 Specifications

Massey Ferguson Tractor Manufacturing Facility at Beauvais,  
France wins French Factory of the Year Award 2016  
"L'Usine Nouvelle"



# Beauvais, France | Centre of Engineering and Manufacturing Excellence



Anyone who buys a Massey Ferguson tractor today will expect it to fulfill the latest operational and environmental standards. They will expect it to combine the very best of today's technologies with comfort, simplicity, reliability, quality and best farming experience.

The MF 7700 S series is designed and built at AGCO's manufacturing facility at Beauvais, France, winner of France's prestigious Factory of the Year 2016 award, organised by L'Usine Nouvelle, the leading industrial magazine in France.

The Beauvais site designs and manufactures Massey Ferguson tractors from 75-400hp and is France's largest producer and exporter of farm machinery. The site is also ISO 9001 certified.

The €300m investment made over the last five years in the Beauvais tractor plant, home of Massey Ferguson's high horsepower range of tractors, has been carried out with a singular aim: to ensure Massey Ferguson tractors are built to standards of quality, reliability and productivity that guarantee peace of mind for the owners and operators who depend on them.

This is at the heart of everything we do at Beauvais. Our engineers have farming in their blood and visionary power. They are eager to develop new solutions to the complex challenges of today's and tomorrow's farming, such as fuel-saving Selective Catalytic Reduction (SCR), which we were first to bring to the market. The result is tractors which help you farm more efficiently and more profitably.



**2,500+** employees

The plants combined cover **30+ hectares**  
Boasts impressive credentials

The **Beauvais plants** are at the forefront of **Massey Ferguson's SUCCESS** responsible for the **design & production** of the latest

**300 million Euros** invested for Beauvais plants during the **Last 5 years**

**925,000+** Massey Ferguson tractors have been built since **Beauvais 1** site opened for business **22<sup>nd</sup> November 1960**

Tractor power range **75-400 hp**

Daily production up to **100** tractors

**85%** of the production shipped to **70+** countries globally

MF 4700  
MF 5700  
MF 6700  
MF 6700 S  
MF 7700 S  
MF 8700 S

## MF 7700 S – Born to Farm

Building on the hugely successful MF 7700 Series, winner of many awards across Europe, the MF 7700 S continues the trend set by Massey Ferguson for highly dependable, straightforward, low maintenance tractors that provide efficiencies across all farming operations to make your farming business more profitable.

The MF 7700 S tractor series from Massey Ferguson has been specifically designed to meet the needs of farming professionals, whatever your business environment and operations, from mixed farming to arable and contracting businesses. With a wide choice of power, transmissions, cab specifications, hydraulics and PTO options, the MF 7700 S can be adapted to your every demand, offering a wide range of custom-built practical, straightforward and dependable solutions.

**A Superior Farming Experience** - In the MF 7700 S, the engine, the transmission, the steering, the PTO and the hydraulics work together in perfect harmony to complete your farming tasks efficiently. This partnership offers easy and precise operation when driving on the road or manoeuvring and an unrivalled, productive working experience in the field.

**With eight models to choose from, this is one of the best choices that you will make.**



MF 7700 S

	MF 7714 S	MF 7715 S	MF 7716 S	MF 7718 S	MF 7720 S	MF 7722 S	MF 7724 S	MF 7726 S
Engine Type	AGCO POWER 6.6 Litre/6 cylinder SCR					AGCO POWER 7.4 Litre/6 cylinder SCR		
Transmission Type	Dyna-4	Dyna-4 Dyna-6 Dyna-VT	Dyna-6 Dyna-VT					
Max Power (hp)	140	150	160	175	200	215	235	255
Max Power with EPM (hp)	165	175	185	200	225	240	260	280
Max Torque @ 1,500 rpm with EPM (nm)	687	745	790	840	980	1050	1120	1146

# Highlights

The renowned AGCO Power Engine for excellent reliability, using pioneering SCR Technology since 2008 with the proven record of 50,000 SCR tractors sold globally. Perfectly combined with the ultimate transmission choices for maximum outputs, and now with the addition of EPM across the board to provide extra power when most needed to get the job done more efficiently

Ultimate comfort for a more productive working day from a cab that blends comfort, quietness, ease of use and quality with easy cab access using large opening doors. Cab suspension and new front axle suspension for optimum ride in the most difficult fields are complemented by controls offering optimum ergonomics and reduced fatigue, with functionality designed for the maximum efficiency whatever the task.

Capable to working more effectively with the most demanding of implements using high lift capacities and a wide choice of PTO and hydraulic specifications. The latest technology from ISOBUS and Auto-Guide™ Guidance solutions helps to get the best out of sophisticated equipment, while improving ease of use for the operator.

Low cost of operation from AGCO Power engines with the lowest fuel and AdBlue® consumption plus a maintenance-free exhaust system. The Super Eco transmission further cuts fuel costs in road applications, while Auto-Guide™ guidance and AgControl™ variable rate control reduces overlaps and chemicals use. Easy and convenient daily maintenance reduces workshop bills, and fleet managers can monitor and optimise machine performance using AgCommand® telemetry.

The face of the New MF 7700 S captures and holds your attention. At its centre is the iconic MF triple triangle logo, around which flows the powerful shape of the MF bar lights iconic to the MF S effect : the whole design exudes amazing power, engineered quality and distinctive style.

The New MF 7700 S with its powerful new styling is designed to captivate you from the start. The NEW MF light bar and iconic MF triple triangle logo is at the heart of the 'S' effect distinctive styling, the full embodiment of MF's power, design and engineering quality.



## MF 7700 S – **Bodyscan your new profit centre**

The new MF 7700 S is designed for ultimate efficiency and low cost of operation using a range of the latest straightforward and dependable technologies.

### **Because we know that a tractor is a profit centre for your business**

The MF 7700 S is a profit earner in any sector – right from the very first day.

Efficient drive-lines, advanced compliance with the Tier 4 final emissions standard, low fuel consumption, long service intervals, impressive traction and lifting capacities together with low maintenance costs – the MF 7700 S simply makes your farming business more profitable. And increasingly so with every hectare that you work.

### **Ultimate comfort for more productive working day**

Cab and front axle suspension improves driving comfort while the coloured dashboard offers better visibility throughout the working day and features the Setup & Information Screen (SIS) with ergonomic navigation method. A choice of three specification levels to meet your needs.

### **Low cost of operation**

- Massey Ferguson SCR “High Efficiency” technology provides low fuel consumption
- Maintenance free components
- Easy access to daily maintenance
- Increased maintenance intervals (600 hrs for the engine)
- **MFCare** Repair and maintenance contracts schemes

### **Efficient drive-lines bring higher productivity**

proven Dyna-4 and Dyna-6 powershift transmissions, plus the Dyna-VT transmission with Engine Power Management to deliver more power when it is needed most. Perfect engine/transmission combinations provide maximum outputs.



**Straightforward Fuse Technologies provide the latest user friendly precision farming and management solutions.** New optional Fieldstar 5 terminal provides the latest user friendly **Precision Farming Package**

- 9" touch screen terminal created to provide a more intuitive and precise farming experience.
- New Auto-Guide™ solutions provide economy by reducing overlaps.
- AgControl™ allows you to adjust the application rate on the go, whilst automatically minimising overlap, skips and wasted product.
- TaskDoc™ creates and sends securely detailed records of jobs to the office.
- AgCommand® telemetry for fleet performance and usage management.

**Ability to work faster with most demanding implements.** Up to five spool valves to the rear and three to the front, including front linkage, and power beyond installation, plus an high lift capacity hitch. The hydraulic system offers the ability to work faster with the widest implements while increasing versatility.

7700 S

# The Smart Generation of Cost Effective Power

Some people say that looking into the future is a futile business. For Massey Ferguson and our Engineering department, it has always offered an exciting challenge. But that's not all. Our engineers have always wanted to influence the future in order to offer highly efficient and powerful engines while minimising fuel consumption. These qualities can have a significant effect on a business's bottom line as well as helping to meet the industry's environmental commitments.

## The benefits of SCR Technology for modern farming

AGCO POWER six cylinder 6,6 and 7,4l engines generate maximum power from 140 to 255hp and up to 280hp with Engine Power Management (EPM)

Maintenance-free, third generation SCR Technology cuts downtime and costs

Turbocharger with electronic wastegate installation for higher power capacities and best engine response at all engine revs.

Optimised high pressure common rail fuel injection limits the emissions of Particulate Matter (PM) and means there is no need to fit a Diesel Particulate Filter (DPF) to meet the latest T4 final legislation requirements.

Automatic low idle system cuts engine revs to save fuel when idling while cutting noise levels in the cab for improved operator comfort.

Tractor power is available at any time as there is no need for a Diesel Particulate Filter (DPF) regeneration.

Back in 2008, Massey Ferguson, together with AGCO Power, pioneered Selective Catalytic Reduction (SCR) Technology as the most straightforward, maintenance free solution to comply with the toughest emissions legislation without compromising on power and productivity.

This is now the industry standard but we are still leading the way with 50,000 tractors equipped globally!

**While helping to preserve the environment for future generations, the only impact on farming businesses has been a highly positive one – cutting fuel bills.**





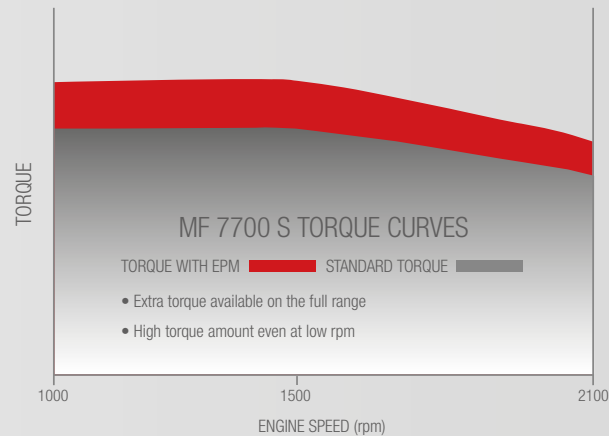
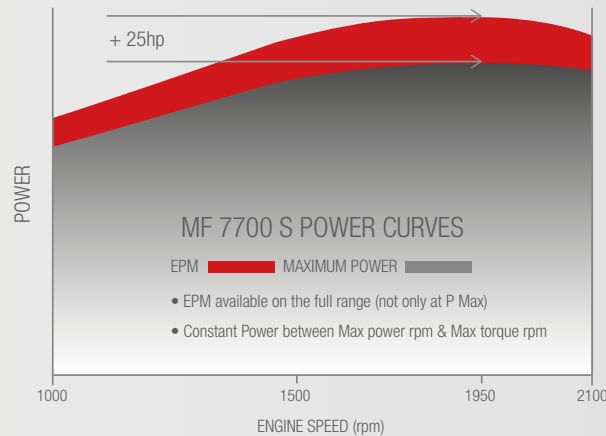

## Engine Power Management

### more muscle when you need it most

Previously only available on tractors with Dyna-4 and Dyna-6 transmissions, Engine Power Management (EPM) is now also available on all MF 7700 S Dyna-VT models, offering up to 25hp more when it is most needed.

EPM means a tractor that responds automatically to the load imposed on it, and adjusts fuelling accordingly to give you extra power when you need it most. Designed to tackle tough transport and PTO work challenges, advanced electronic engine and transmission management makes more power automatically available under load or at speed.

EPM works by way of transmission electronics which monitor the load and operating conditions within the transmission and PTO according to forward speed, transmission load and PTO activation. This information is then communicated to the electronic engine management system, which regulates accordingly the exact quantity of fuel required and the timing at which it is applied.

Engine Power Management requires no operator input and engages automatically for PTO or hydraulic work above 0.1km/h, or for traction or transport applications, above 8km/h (Dyna-4), 6km/h (Dyna-6) and 15km/h (Dyna-VT). Engine Power Management delivers the maximum extra power when both conditions apply (PTO/Hydraulic and forward speed).



Highlights

- EPM available on the whole Power range, not only at P Max
- High level of constant power between Max Power and Max Torque rpm
- Torque increase with active EPM on the whole range
- Stable low fuel consumption between Max. Power and Max Torque.

# The Dyna transmissions

## When it comes to drive power, we've really shifted up a gear

Whether your workload demands a semi-powershift or continuously-variable transmission, MF 7700 S tractors can be specified with the format that fits your farm. Dyna-4 and Dyna-6 options offer four and six powershifts respectively, in each of four ranges, which can all be controlled from the armrest joystick, the transmission control lever or the Multipad lever (depending on model).

The unique MF Power Control lever on the left side of the steering column provides a PowerShuttle feature, as well as an alternative method of transmission ratio changing and a de-clutch function. Shuttle response can be adjusted according to operator preference.

Massey Ferguson's Dyna-VT Continuously Variable Transmission continues to be one of the most popular transmissions offering maximum productivity, efficiency and operator comfort.

### All Dyna transmissions benefit from:

- Exclusive and straightforward left-hand Power Control lever
- Pedal-free operation, which reduces operator fatigue and makes life easier on the operator
- Plenty of gears in the important 4-12km/h working range, with good overlaps
- Autodrive as standard, taking automatic care of up- and downshifting to maximise versatility and output. Response point can be now automatic or adjustable according to desired engine rpm parameters
- Brake to neutral feature disconnects drive when the brake pedal is pressed
- Shuttle responsiveness can be adjusted according to speed of change required
- Progressive adjustment for Dynashift ratios
- Up to 2 cruise control speeds (depending on version)



### Multipad lever

The Multipad lever controls the rear linkage, PTO, headland management, spool valves and cruise control, as well as operating the transmission. All operations are easily to hand for greater comfort.



### Right-hand T-handle

Simply move the T-shaped transmission control lever forwards or backwards to change up or down through the 4 or 6 Dynashift ratios. To change range, simply press the range selection button as you move the lever.



### Simple, multi-function Power Control

The Power Control lever provides convenient three-in-one, straightforward operation. Operators can shuttle between forward/reverse, shift Dynashift speeds and ranges and select neutral, leaving the right hand free to operate the loader or implement hydraulics.

- Neutral
- De-clutch
- Forward drive
- Reverse drive
- Change up ratio
- Change down ratio

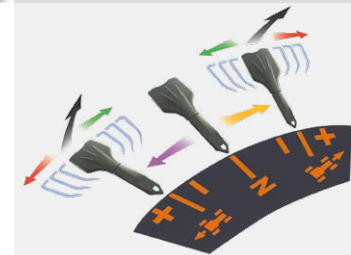

## A SHIFT TO THE RIGHT CHOICE -

These are the best choice of transmissions ever.  
Easy to use. Smart to operate. Efficient and comfortable



Transmission	Dyna-4	Dyna-6	Dyna-VT
MF 7714 S	●		
MF 7715 S	●	●	●
MF 7716 S		●	●
MF 7718 S		●	●
MF 7720 S		●	●
MF 7722 S		●	●
MF 7724 S		●	●
MF 7726 S		●	●

MF 7700 S

# Dyna4 – four-speed flexibility

Dyna-4 offers first-rate productivity. The dynamic performance and efficient design behind the Dyna-4 transmission continues to impress with incredibly smooth four-speed, powershift change in each of the four ranges, giving you first-rate productivity, every time.

Dynamic performance comes from the optimised design of the Dyna-4 transmission. Well-known features include Power Control, 'pedal-free' operation, four-speed PowerShift, Speedmatching and Autodrive.

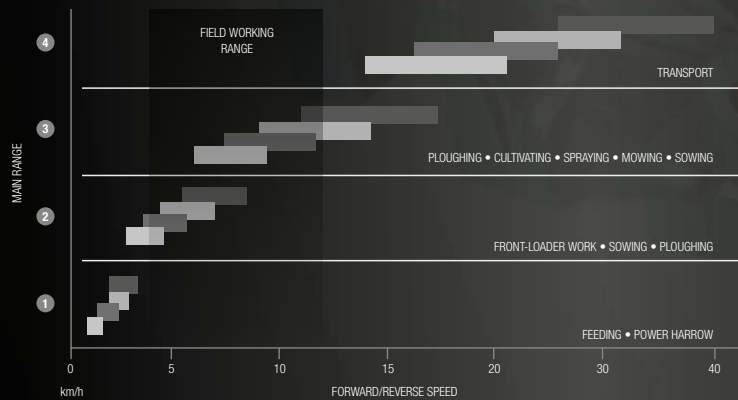
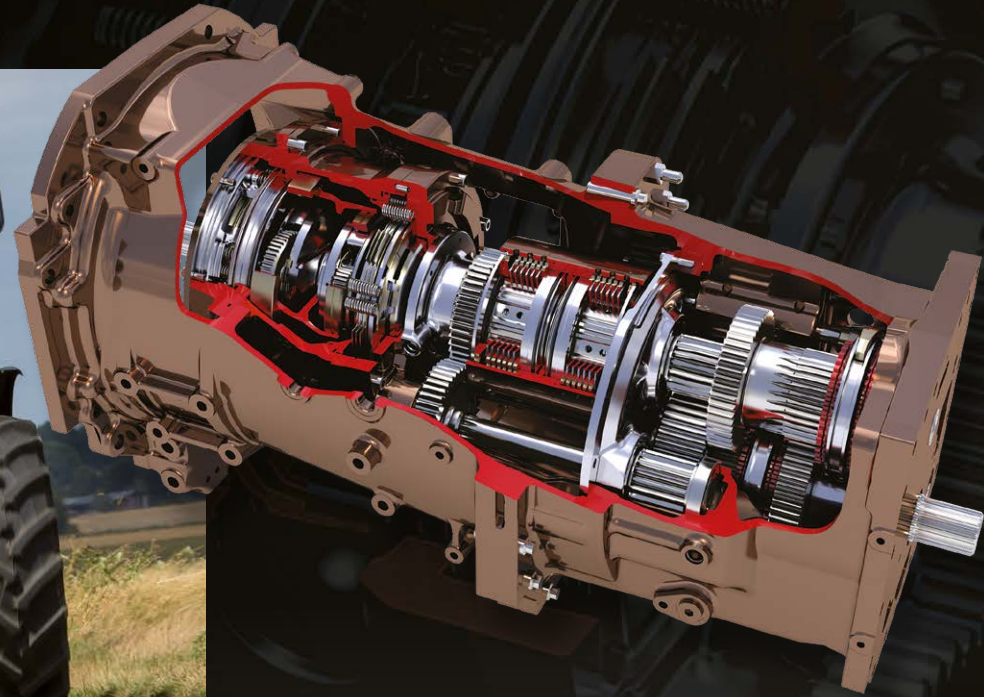

Dyna-4 offers four Dynashift changes in each range with excellent overlaps Field Working range to ensure you can always select the right speed to suit all tasks and conditions.



## Dyna-4 Highlights:

- Exceptional performance in the yard, field or on the road – 16 forward and 16 reverse speeds, all shifted without using the clutch
- Operation is simple and less repetitive with ergonomically placed controls, reducing operator fatigue and stress
- Ultimate ease of use with left-hand Power Control lever, T-Lever or Joystick control
- The choice of pedal and lever mode minimises operator effort and maximises productivity
- Straightforward design and proven, reliable components provide exceptionally smooth operation with strength and longevity
- Pedal mode AutoDrive with Automatic setting
- Brake pedal puts transmission in neutral

## Dyna6 – performance, refined

Dynamic performance comes as standard with Dyna-6 transmission. Now, this ultra-reliable, semi-powershift gearbox is even more refined.

The ultimate semi-powershift transmission in the field today, Dyna-6 combines effortless operation with complete efficiency to create an extraordinary operator experience.

Dyna-6, uniquely, provides a smooth, 6-speed Dynashift change in each of four gears, giving a tremendous range of powershift flexibility over a wide speed range, giving maximum field performance. Both Dynashift and range changes are made under load, without the need to use the clutch pedal.

Dyna-6 comes with Eco as standard - reducing engine speed at maximum forward speeds providing a quieter drive and less fuel consumption.

The 40km/h Super Eco or or 50 km/h Eco transmission is standard on MF 7720 S to MF 7726 S Dyna-6 for reduced engine rpm at 40km/h giving the lowest fuel consumption and less noise in transport applications.

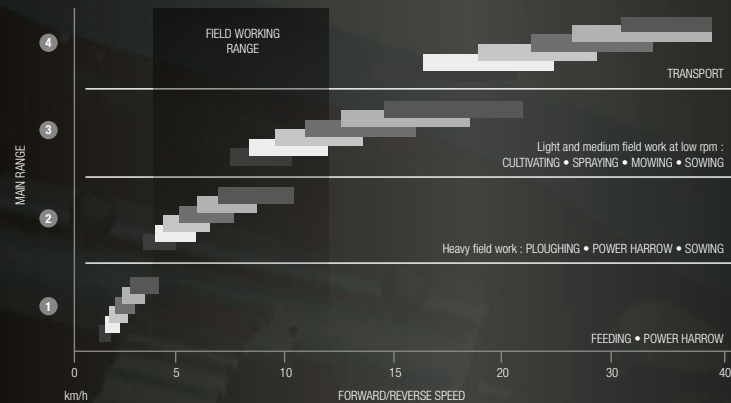

Dyna-6 offers six Dynashift changes in each range providing 24 forward and 24 reverse speeds, with an excellent overlap and a total of nine speeds in the Field Working range.

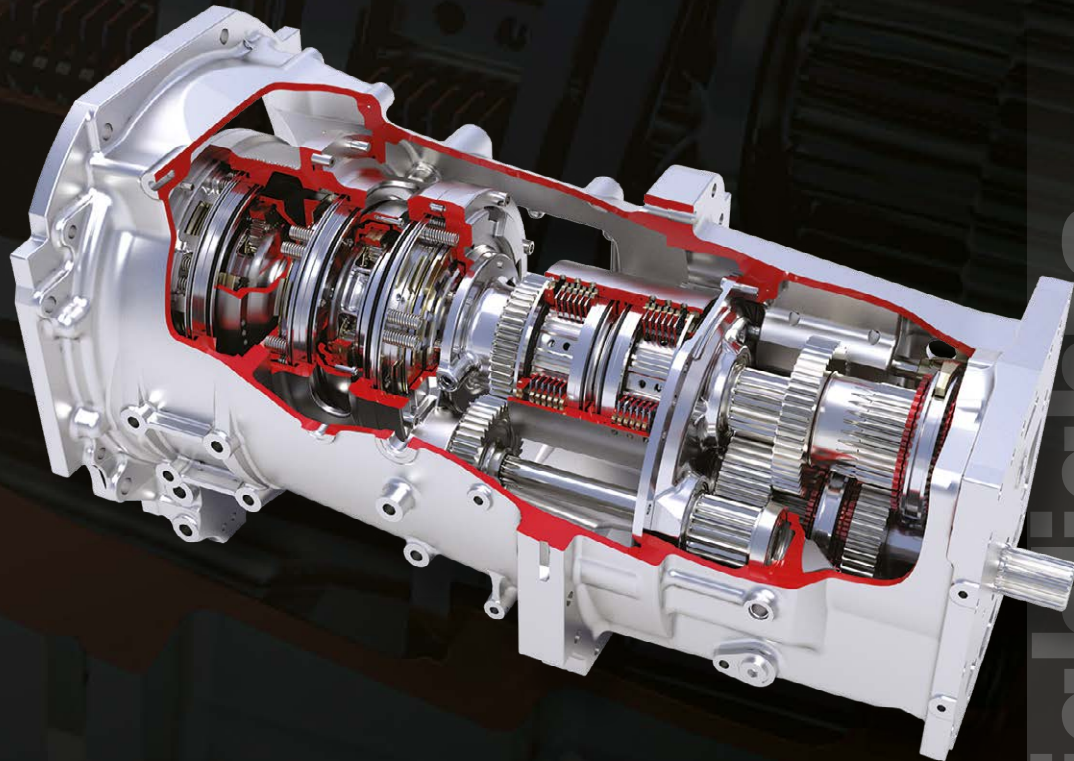

### Dyna-6 Highlights:

- Six Dynashift (powershift) ratios
- Maximum productivity with 24 forward gears and 24 reverse gears
- Power Control Lever with three functions on one lever - Forward/Reverse shuttle, declutch, upshift and downshift
- Nine speeds in the Field Working range
- 40 Km/h or 50 Km/h maximum speed available\* at low engine speed (Eco)
- Eco feature allows top speeds to be achieved at low engine revs, offering a reduction in noise and fuel consumption
- The 40km/h Super Eco transmission on MF 7720 S to MF 7726 S Dyna-6 for reduced engine rpm at 40km/h for lowest fuel consumption and less noise in transport applications.
- Cruise control speeds (C1/C2)
- Brake pedal puts transmission in neutral
- Reverse shuttle aggressiveness adjustment, separate adjustment for forward and reverse
- Aggressiveness adjustment for Dynashift (powershift) ratios

\* Depending on market/legislation.

## DynaVT – the tractor transmission without limits

With the continuously-variable Dyna-VT transmission, we have developed a system of power transfer that surpasses all others for ease of use and precision. The Dyna-VT is a proven and refined transmission delivering seamless strength hour after hour. It's intuitive to the operator, the easiest of transmissions to understand and get the most from, and new operators will quickly settle into feeling at one with the machine. Combined with Engine Power Management, Dyna-VT allows you to get the optimum performance, efficiency and economy from your tractor.

### Dyna-VT Highlights:

- 0.03 to 40 km/h or 50 km/h\*
- 40 km/h super Eco or 50 km/h\* Eco
- The choice of two speed ranges optimises torque for different applications
- Lever, pedal, or automatic mode
- C1/C2 cruise speeds
- 'Supervisor' maximises the output under varying loads
- Dynamic Tractor Management (DTM) maintains the set travel speed by automatically adjusting the power (engine speed) according to load
- Engine Power Management now available to give extra power when needed
- Active Stop
- High efficiency and superior comfort
- Pedal aggressiveness adjustment
- Switch between cruise speeds (C1 and C2)
- Brake pedal to neutral feature

\*Depending on market legislation.

MF7700S

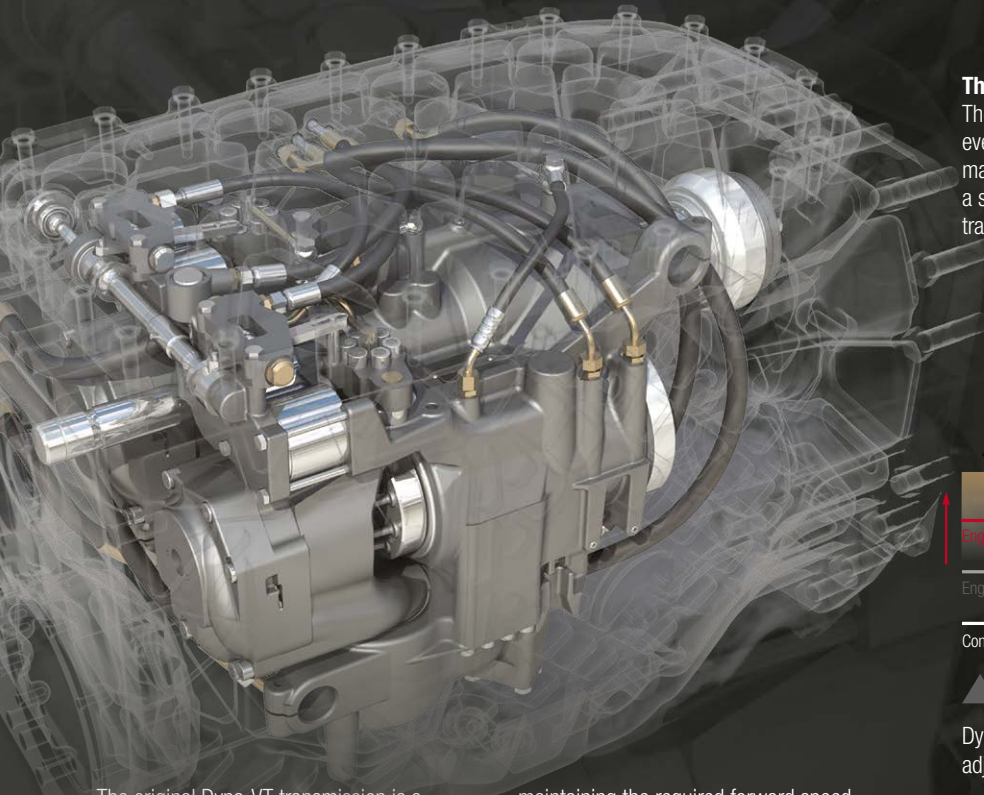

### The 'Supervisor'

The 'Supervisor' is on continuous stand-by and activates when engine speed falls under load. The benefit of the 'Supervisor' is that even when the load on the engine is increased and engine speed drops, the transmission will automatically reduce forward speed to maintain total power, whether in PTO applications, field work or transportation. When used in conjunction with C1 and C2, which set a specified forward speed, the tractor will then operate at maximum output as load fluctuates as well as automatically adjusting the tractor back to the required speed

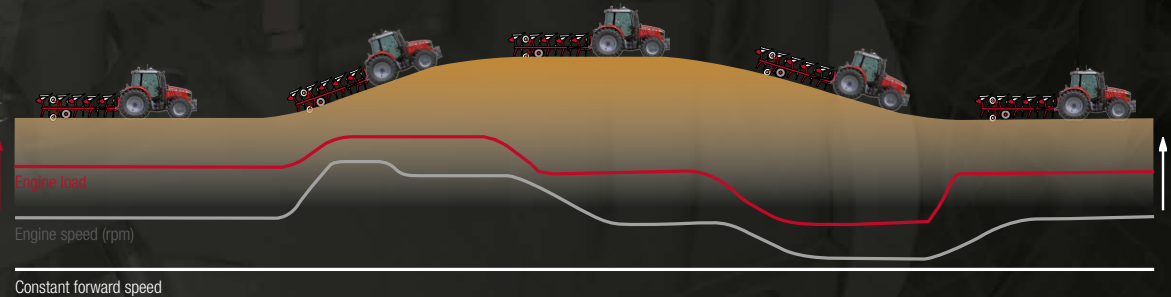

Dynamic Tractor Management (DTM): As the load (red line) varies according to the conditions, the Dyna-VT will automatically adjust the engine speed (grey line) to maintain the forward speed whilst minimising fuel consumption and noise levels.

The original Dyna-VT transmission is a true testament to precision engineering; guaranteed productivity, complete operator comfort and optimum fuel efficiency at all times. Further, consistent enhancements such as Dynamic Tractor Management (DTM) make it the most intuitive transmission on the market.

Stepless precision Dyna-VT is amazingly simple to operate and works extremely well in differing conditions. There's no shifting of gears, no jolts and no breaks in traction or power. The unique Power Control lever makes forward/reverse shuttling and speed change convenient and hassle-free.

Dynamic Tractor Management works in conjunction with the Dyna-VT transmission, in either lever or pedal mode, to automatically control engine speed according to the load on the tractor,

maintaining the required forward speed whilst keeping rpm to the minimum necessary. It works from 1000-2100 rpm, with the operator able to set both a lower and an upper limit within the range. DTM can be activated with triggers such as PTO, Linkage or hydraulic activation. The result is smoother driving and excellent fuel efficiency.

The EPM - Engine Power Management is available on the Dyna-VT, combining additional power with precision. This means a tractor responds automatically to the load imposed on it, and adjusts fuelling accordingly to give you extra power when you need it most. Designed to tackle tough transport and PTO work challenges, advanced electronic engine and transmission management makes more power automatically available under load or at speed.

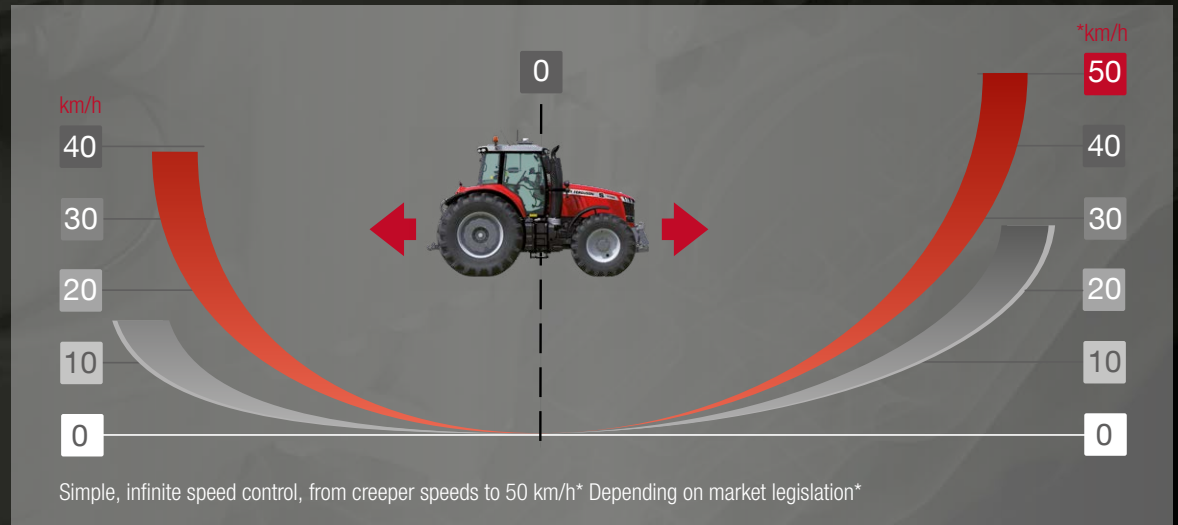

# Welcome to your 'Farm office'

From the origins of modern tractor design, the Massey Ferguson cab has been renowned for excellence, and the MF 7700 S moves that legacy a step forward. It's something we work hard for, so you can sit and reap the benefits when days go on and on, in a very productive environment that blends comfort, quietness, ease of use and quality. **Because we know that a more productive operator is an operator who creates profit for his business.**

## And there's more in it for you!

The better equipped a tractor is for the job in hand, the easier and more efficiently the job can get done. This is another area where the MF 7700 S really stands out of the crowd: as well as an extensive standard equipment package, it comes with a choice of different cab environments offering a wide range of equipment, giving you all the options that you need.

**You can make your new MF 7700 S as individual as your farm.**

**Ergonomics** – Everything you need in one place to make the working day go smoothly. Easy access to the cab, vital operating information where you need it with the new dashboard, and all major controls conveniently to hand on the right armrest. This tractor has been designed with the operator in mind.

**Efficiency at work** – Boosting productivity, saving time and making the difference. Work smarter with implements and drive safely on the roads with 360° cab visibility. Be more productive with during a long day with the new MF 'Quadlink' suspended front axle, cab suspension and a choice of seat specification.

**Essential, Efficient or Exclusive – Your Choice!** - Three variations of ways to work. There is no compromise, simply a personal choice to be made to fit your business requirements and objectives. We offer you the freedom to choose your level of comfort and equipment's to match your exact needs – Freedom amongst all details – Personalise your own MF 7700 S tractor with your transmission choice, cab version and equipment.



## Little extras make a big difference

Sometimes it's the small details that can make a huge change to your workload. The MF 7700 S cab is available with numerous comfort and convenience features. These include automatic beacon activation on the road, comfort light delay at end of the day with automatic work lights extinction, extra plug sockets for mobile phones or laptop, radio and MP3 player (USB, Aux and CD), Bluetooth connection, DAB + (digital) radio air suspended swivel seat, telescopic side mirrors and electric de-icing, plus automatic air conditioning. The addition of the 16 LED working lights option transforms night into day with its outstanding brightness capacity. This package also includes day time running LED signatures, enhancing an already very attractive design.



Standard roof with hatch



Visio roof with FOPS



## Cab suspension brings extra comfort

Two types of cab suspension are available - mechanical and NEW active mechanical.

Both systems offer unprecedented levels of cab comfort.

The NEW active mechanical system uses silent block bushes and spring-assisted shock absorbers providing optimum damping forces for all driving situations and the reduction of heave/pitch and roll movement.

Active mechanical cab suspension is adjustable, allowing the operator to set the firmness of ride. Adjustment means the operator can control the ride feel according to differing terrain and speed.

## Tailor the roof to fit

A choice of roof types allows you to tailor your MF 7700 S Series tractor to offer for improved visibility for loader work or to increase ventilation.





### New Dashboard with SIS – Setup and Information Screen

The slim dashboard design provides for quick, clear and easy analysis of operating data, presented on a 70mm x 52mm colour screen – the Setup and Information Screen (SIS). The large and high resolution screen makes information on tractor performance, working area, working distance, fuel and urea consumption or engine and transmission temperature easier to read.

The coloured dashboard also offers better visibility throughout the working day, especially in poor light or at night. Its integrated clock will keep you on time.



# Essential

## The new standard for straightforward operation



Essential is the base specification for the MF 7700 S Series, but it is anything but basic. It provides all the key elements you would expect from Massey Ferguson, with a blend of simplicity, ease of use and versatility to fit needs that require power and performance without excess sophistication.

The right hand console on Essential models features a T-Lever transmission controller, hand throttle with engine speed memo A switch and linkage control. All of the main controls are at your fingertips for maximum convenience and control, whatever the operation. On the console you will also find spool valve and PTO controls.

The right hand pillar contains less frequently-used switches, working light controls and the ignition key.

Worklights and  
beacons  
control panels

Electronic  
rear linkage  
adjustment



Up to four lockable spool valves can be specified as an option

Transmission control lever for effortless speed and range changes

Hand throttle

Electronic linkage control

Linkage depth control



### Essential cab control with loader joystick

Essential specification tractors are also available with a multifunction loader joystick, which works seamlessly with the fully-compatible range of Massey Ferguson loaders.

Specifically designed for use with MF loaders, the design of the unique multifunction loader joystick ensures smooth operation and incorporates transmission functions such as forward/reverse selection for the easy, efficient materials handling, whether in the yard or in the field.

#### Standard Essential features include:

- Control Centre with T-handle transmission lever
- Dyna-4 or Dyna-6 with Autodrive
- Brake to Neutral
- Engine speed memory A
- Air conditioning with manual adjustment

#### Essential specification options:

- Quadlink suspended front axle
- Mechanical cab suspension
- Integrated front linkage
- 1000 Eco rear PTO
- Loader-ready from factory with Multifunction mechanical joystick\*
- Closed Centre Load Sensing hydraulics\*
- AgCommand® Ready
- New Fieldstar 5 Terminal for full precision farming package including Auto-Guide™ guidance system, AgControl™ for variable rate control and TaskDoc™ as well as video and ISOBUS compatibility - see details p.34
- Panoramic cab with polycarbonate right-hand side window\*

\* MF 7714 S to MF 7716 S

## The Essential Panoramic cab option

The MF 7700 S Series Panoramic cab offers unobstructed visibility to the right hand side for safe and efficient operation of side-mounted equipment. The wide, one-piece polycarbonate screen is extremely tough and protects operators from flying debris.

A special anti-scratch coating and dedicated wash/wipe system maintains great visibility in all conditions. For local authority and road work operations the cab can be equipped with fixing brackets and wiring for hazard warning lights and signs.

This cab option will allow a farmer/contractor to diversify his business into roadside maintenance contracting for local authorities.



# Efficient

## Advanced equipment to heighten your efficiency at work



Efficient is the medium specification package for the MF 7700 S Series, designed to help you work smarter and get better results. Choose from either Dyna-6 or Dyna-VT transmissions, a Command Control Armrest and mechanical or electronic spool valves.

Dedicated to delivering increased productivity thanks to its key features, the Efficient specification will enable the operator to work faster, to a higher standard, with more accuracy, together with high levels of comfort, ergonomics and reliability. Stay in control of the most technologically advanced and demanding implements to take advantage of their increased productivity.

### Standard Efficient features include:

- Dyna-6 Autodrive or Dyna-VT transmission
- Command Control Armrest with T-Lever
- Cruise speed control and Brake to Neutral
- Quadlink front axle
- Standard Air Conditioning
- Mechanical Cab suspension
- Closed Centre 110 l/min hydraulics
- Electrical and mechanical spool valves

### Efficient specification options:

- 50 km/h Eco Dyna-6 and Dyna-VT\*
- Multipad Lever
- Automatic Air Conditioning
- Radio, CD, MP3, Bluetooth connexion, USB & Front auxiliary
- Mirrors with electric de-icing and adjustment
- Datatronic 4 to manage all tractor functions with video capabilities
- Integrated front linkage with independent valve
- SpeedSteer
- Loader ready from factory with Multifunction electrical joystick
- Mechanical active cab suspension
- AgCommand®
- New Fieldstar 5 Terminal for full precision farming package including Auto-Guide™ guidance system, AgControl™ for variable rate control and TaskDoc™ as well as video and ISOBUS compatibility - see details p.34

\* depending on market/legislation.



## Efficient cab control with optional joystick

Efficient specification tractors are also available with a multifunction joystick.

The multifunction joystick adds front linkage control capability for even greater productivity when operating front- and rear-mounted implements.

Specifically designed for use with the Integrated Front Linkage System, the design of the unique multifunction joystick ensures smooth operation and incorporates transmission functions such as forward/reverse selection for silage packing and snow blading.

In addition the H3/H4 switches can be set to control additional functions such as rear linkage control, cruise control.

This multifunction joystick, which works seamlessly with the range of Massey Ferguson MF loaders, enables efficient materials handling, whether in the yard or in the field.



### 'Multifunction' joystick main functions:

- A. Lift front linkage or rear valve control +
- B. Lower front linkage or rear valve control -
- C. Front or rear valve control +
- D. Front or rear valve control -

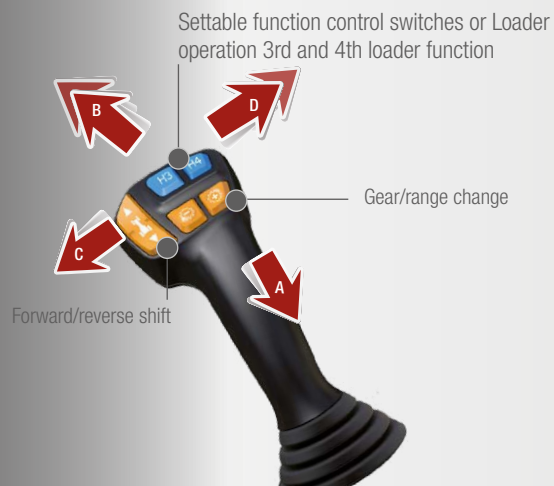

### Datatronic control centre display

An option on Efficient tractors, the Datatronic 4 has a perfectly-positioned 7" colour monitor mounted to the operator's right. The Datatronic 4 displays important tractor information, records and shows memory functions and tasks, and oversees automation of headland management, Trailer steering axle management and Dual Control. The Datatronic 4 can be connected to a camera for improved visibility of rear mounted implements and trailers.

# Exclusive Package

## The ultimate expression of productivity and innovation

Exclusive is a combination of high-spec versatility and refinement dedicated to operators looking for a tractor with advanced features and functions in terms of ergonomics, comfort and automation.



The package is aimed at more intensive, large scale operators looking for more advanced features that will ensure cost-effective benefits for their business.

The Exclusive armrest comes with numerous benefits including comfort and convenience when operating multiple, frequently-used controls.

Exclusive also adds the Datatronic 4 as standard. Use the 7" colour monitor to view important tractor information, records and utilise memory functions. The Datatronic 4 also oversees automation of headland management,

### Standard Exclusive features include:

- Command Control Armrest with Multipad lever
- Dyna-6 Autodrive or Dyna-VT transmission
- Cruise speed control and Clutch Effect
- Quadlink front axle
- Automatic Air Conditioning
- Mirrors with electric de-icing and adjustment
- Datatronic 4 to manage all tractor functions with video compatibilities
- Dual Control and Headland Management System
- AgCommand®
- Closed Centre 110 l/min hydraulics
- 4 electronic spool valves with fingertip controls
- Mechanical active cab suspension

### Exclusive specification options:

- Radio, CD, MP3, DAB + radio Bluetooth connexion, USB & Front auxiliary
- SpeedSteer
- Integrated front linkage with independent valve
- New Fieldstar 5 Terminal for full precision farming package including Auto-Guide™ guidance system, AgControl™ for variable rate control and TaskDoc™ as well as video and ISOBUS compatibility - see details p.34
- Loader ready from factory with Multifunction electrical joystick

\* depending on market/legislation.

trailed implement control (TIC) and Dual Control. Eliminate cab clutter and simplify implement operation with its ISOBUS capability; the Datatronic 4 can also be connected to a camera, used for Trailer steering axle management.

Using the Exclusive package, operate the most technologically advanced and demanding implements with the optimum efficiency to take advantage of their increased productivity.



## Exclusive cab controls with joystick



# Operate your loader the Massey Ferguson way

When you purchase a Massey Ferguson loader with your new MF 7700 S tractor, it can be specified fully MF loader-ready. Your tractor will come complete from the factory with the loader subframe, designed for maximum manoeuvrability and maintenance access, already built on so that it forms an integral part of the machine.

In total control - The optional mechanical multifunction joystick has additional transmission functions such as forward/reverse and speed change for added versatility during operation. A clever new addition to the loader hydraulic control is 3rd Live which enables the operator to open/close a grab and tip or crowd an implement at the same time. This function has been very well received on Massey Ferguson telehandlers, and is now available for the MF FL loader series.

You will enjoy superb visibility thanks to slim bonnet and dash profiles. The optional Visio roof improves vision of loads at height, and is particularly useful when stacking bales, for example. The new 'clutch effect' feature built into Massey Ferguson's latest braking systems can be selected to put the transmission into neutral when the brake pedals are depressed, allowing single-foot brake and clutch operation and making loader operation safer, easier and a lot more comfortable



▲  
Visio roof with FOPS



## Tractor/Loader combination highlights :

- A flexible range for a wide variety of applications
- Optional multifunction joystick comes with forward/reverse and speed change for added versatility
- Highest visibility thanks to the smart design of the bonnet and the slim dashboard
- Factory fitted loader subframe for optimum performance from your all-purpose tractor
- 3rd live - A clever addition to the loader hydraulic control that enables the operator to open/close a grab and tip or crowd an implement at the same time.
- Optimum manoeuvrability and access to maintenance operation
- Optional Visio roof\* with Falling Object Protection (FOPS)
- Excellent manoeuvrability with tight turning angles, SpeedSteer and rapid response from engine and hydraulics

\* MF 7714 S to MF 7718 S

## Loader operation

Joystick main functions:

- A. Lift
- B. Lower
- C. Fill
- D. Dump

Combined functions:

- A/C. Lift and fill
- A/D. Lift and dump
- B/C. Lower and fill
- B/D. Lower and dump
- A/C/E. Lift and close grab
- A/D/F. Lift and open grab

Combined functions with 3rd live:

- C/E. Fill & close grab
- D/F. Dump & open grab
- A/C/E. Lift, fill & close grab
- A/D/F. Lift, dump & open grab





“The beauty of this joystick means you can go from forward to reverse and operate the loader at the same time, without taking your hand off the steering wheel.”

# MF 7700 S

Model compatibility	
MF 7714 S/ MF 7715 S/ MF 7716 S/ MF 7718 S	●
MF 7720 S/ MF 7722 S	-
MF 7724 S/ MF 7726 S*	-
Maximum Lift Height - Measured at Pivot Pin	
MF 7714 S/ MF 7715 S/ MF 7716 S/ MF 7718 S	m 4.25
MF 7720 S/ MF 7722 S	m
MF 7724 S/ MF 7726 S*	m
Maximum Dump Angle at Maximum height	
Maximum Rollback Angle at ground	Deg 48
Breakout Force - At Pivot Pin	Kg 3090
Breakout Force - 800mm From Pivot Pin	Kg 2270
Rollback Force at 1,5m Height	Kg 3940
Digging Depth	mm 154

\*: FL 4624/FL4628 not compatible with factory fitted subframe

## MF FL Series loaders

	without parallel linkage	with parallel linkage							
		MF FL.4227	MF FL.4323	MF FL.4327	MF FL.4621	MF FL.4624	MF FL.4628	MF FL.4722	MF FL.5029
		●	●	●	●	●	-	-	-
		-	-	-	-	●	●	●	●
		-	-	-	-	●	●	●	●
m	4.25	4.25	4.25	4.55	4.6				
m				4.55	4.6		4.7		
m				4.55	4.6	4.6	4.7	4.96	4.96
	56.5	56.5	56.5	53	55	55	53	53	53
Deg	48	48	48	51	49.5	49.5	51	47	47
Kg	3090	2640	3040	2350	2760	3150	2540	3380	3860
Kg	2270	2470	2840	2330	2620	2990	2430	3190	3630
Kg	3940	3430	3430	3430	3980	4620	4630	4640	4640
mm	154	154	154	194	154	154	165	165	165

# Versatility means optimised costs

The MF 7700 S is equipped for all types of operation



## The new dimension in traction

Tractor power means nothing if it cannot be transferred to where it matters: the ground. We've put a great deal of research into ensuring that power is usable.

A wide choice of tyre dimensions and ballasts available for the MF 7700 S offers improved traction and low soil compaction for keener operating costs and higher crop yields.

This includes a large rear wheel diameter of 2.05m on the MF 7722 S, MF 7724 S and MF 7726 S Dyna-6, which ensures that the tractors can be tailored precisely to the tasks that are expected of them, for maximum traction with the minimum of soil damage, whilst using the minimum of fuel. That is part of our commitment to help protect the soil and preserve the land for future generations.

**Increased traction and low soil compaction** can be achieved working with the right ballast and tyre choice including tyre pressure.





### Rear hitches to match any applications

The rear hitch with a choice of pintle pin, pick-up hitch, clevis, K80 ball or drawbar has been completely redesigned to make coupling quicker, easier and safer. The ISO hitch is compatible with a wide range of clevis and drawbar alternatives according to markets.

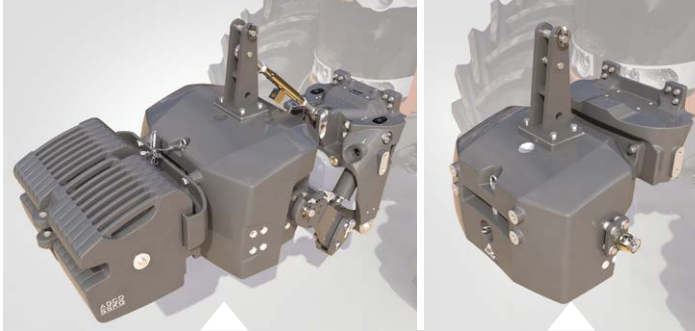

### Ballasting for flexibility

To deal with intensive traction work or counter ballast (front or rear), sometimes you need extra weight, so a wide choice of ballasts is available. The MF 7700 S is available from the factory with additional front and rear weights to exactly match your needs. Extra versatility is offered by the installation of wheel weights from 250 to 500kg on each side, an integrated belly weight and a new design of 850kg or 1500kg monobloc front weight.

The smart new monobloc weight's compact design has a minimal effect on the overall tractor length, boosting manoeuvrability in transport or when on the farm. Ground clearance and road light beam are not compromised. The monobloc weight can be fitted on the front or rear linkage or directly onto the tractor frame where a linkage is not supplied, and weight can be increased further by the addition of suitcase weights to perfectly meet your needs.



### Efficient braking system

Improved safety on the road. All MF 7700 S Series are equipped with air braking systems for the trailers as standard\*, including the option of ABS signal for trailer compliance for ultimate security. A Pedal coupling sensor prevent the tractor from going above 40 km/h for increased safety if the pedals are not linked.

\* Specifications may vary by market



The right balance between ballasts and tyre choices brings:

- More power to the ground
- Ultimate traction capabilities
- Limited soil compaction to boost yields whilst maintaining soil health for the next generation
- Improved fuel economy

## Best in class manoeuvrability



### ▲ Quadlink Front Axle Suspension

Improved comfort and safety for transport applications. Extra comfort and greater traction is delivered by a new and innovative front suspension option, developed by Massey Ferguson. The simple design produces super ride comfort, turning angle and offers the full angle of oscillation as well as maximising ground clearance. Completely maintenance free.

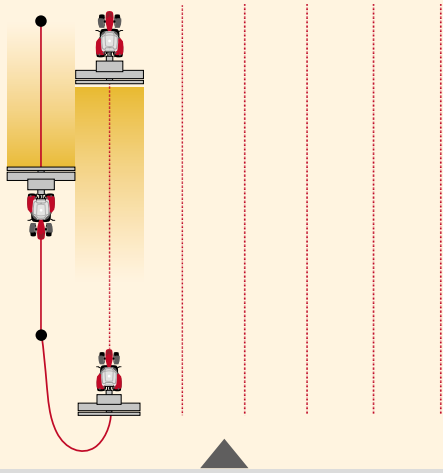

### SpeedSteer for exact turns –

SpeedSteer reduces operator effort and provides faster turns on the headland. This optional feature enables the operator to adjust the steering ratio and select number of turns of the steering wheel required for a given amount of steering angle turns. The system can be switched on and off. Above 18 km/h, it automatically switches off for safe operation at high speed in the field and on the road. Speedsteer simplifies headland turning and maximises productivity in the field and on tasks such as loader operations.



### Wheelbase

Perfect wheelbase for the perfect power. Wheelbase length is 2.88m on the MF 7714 S to MF 7718 S and 3.0m on the MF 7720 S to MF 7726 S. These long wheelbases offer improved stability with or without a heavy implement, maintaining high levels of traction in the field and increased comfort in transport.

The combination of the wheelbase and the MF 7700 S chassis design means that less ballasting weight is needed, ensuring maximum soil preservation and reduced ground pressure during cultivation, drilling and seeding. The ideal wheelbase and perfect power-to-weight ratio ensures the maximum stability to optimise output, promote soil health and preserve the land for the next generation.

### Tight Turning Circle

Improved manoeuvrability for loader operation, in the farm yard and when turning at the headland. The curved design of the chassis and bonnet ensures one of the best turning circles on the market allowing the operator greater freedom to move in tighter areas such as farm yards.

### Four-wheel drive and differential lock

Four-wheel drive enhances traction and ensures effective steering is available in difficult field conditions, while the front and rear differential lock system is linked to four-wheel drive axle engagement to maximise traction in the field.

Massey Ferguson has long been known for making tractor operators' lives easier and maximising traction, safety and productivity through automation, and the MF 7700 S Series takes that a step further by offering automated functions on the differential lock and 4WD systems.

- Automatic disengagement of 4WD and differential lock above 14km/hr
- Automatic differential lock disengagement when a rear linkage-mounted implement is raised (and re-engagement when lowered)
- Automatic differential lock disengagement when either one or both of the brake pedals are pressed (and re-engagement when released)
- Automatic 4WD engagement when both brake pedals are depressed, when the differential lock is engaged or the handbrake applied
- Automatic diff lock activation linked to wheel turning angle.



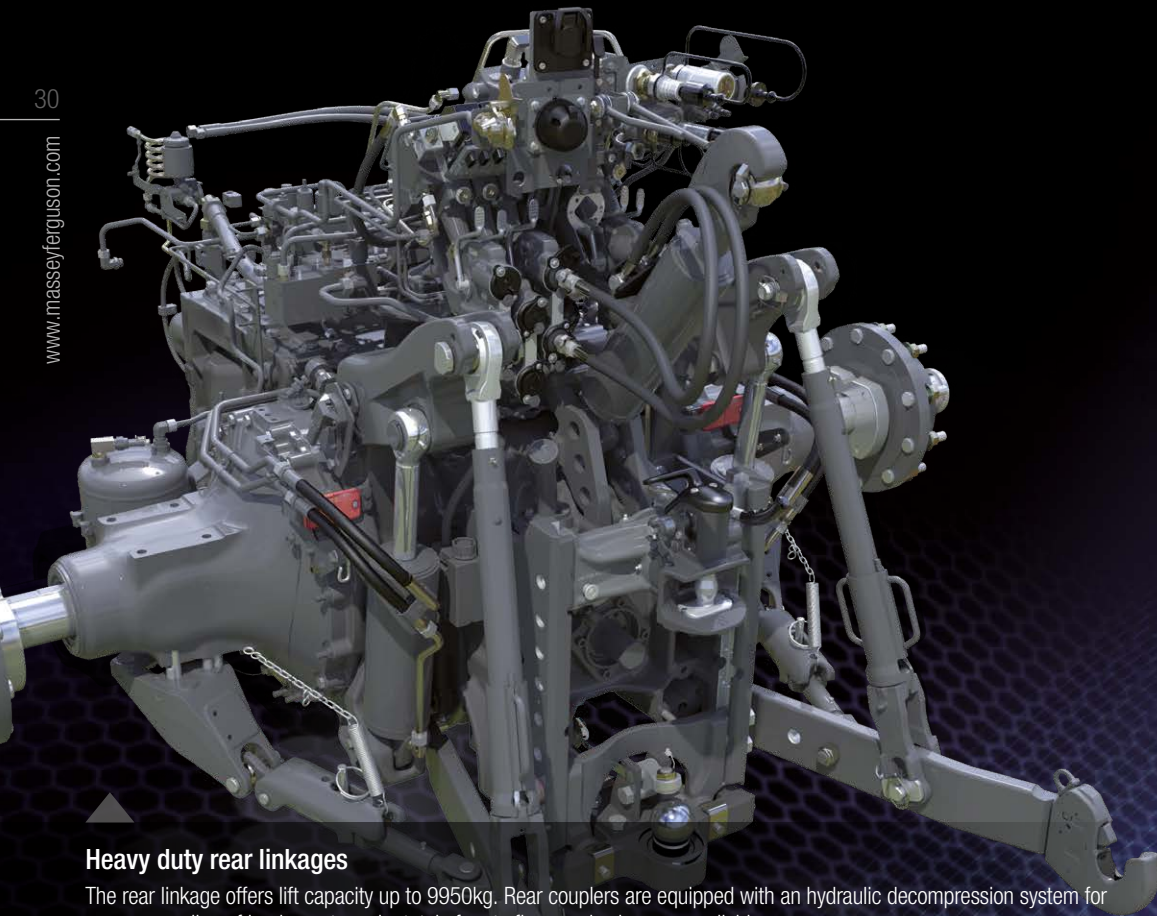

### Heavy duty rear linkages

The rear linkage offers lift capacity up to 9950kg. Rear couplers are equipped with an hydraulic decompression system for easy uncoupling of implements and a total of up to five spool valves are available.

Automatic stabiliser installation has also been improved with a shorter chain for the simplest installation. A one way stabiliser each side offers extra reliability.

### Heavy duty Integrated Front Linkage System (IFLS)

A heavy duty Integrated Front Linkage System (IFLS) is available as an option and is designed to match the front suspension. Offering up to 4000kg lift with dedicated front valve control, the IFLS features two spool valves and a free return line.

## Hydraulic energy to power the most demanding task

Modern implements are placing more and more demands upon the tractors that power them, which are asked to perform faster and respond better. The MF 7700 S comes with immense capability to easily handle heavy-duty applications with outstanding lift and drive capacities for the very latest implements.

Since 1936, we have always been industry leader when it comes to linkage power and hydraulic capability. Massey Ferguson's three-point linkage is the finest example of productivity, power and responsiveness, for the operator in the field. But we have never rested on our laurels when it comes to ensuring our systems meet and exceed the requirements of the very latest implements.

### Our engineers have responded with five hydraulic flow choices for MF 7700 S tractors:

On MF 7714 S to MF 7716 S Essentials are fitted with standard open centre 58 litres/min unit. This uses a high pressure pump to provide 58 litres/min to the rear spool valves and linkage. Two options are available, Massey Ferguson offers 100l/min open center or 110 L/min CCLS.

MF 7718 S to MF 7726 S models are equipped with a closed-centre, load-sensing high-flow 110, 150 or 190 litres/min depending on model system for faster hydraulic response. This uses a variable displacement swash plate pump in addition to the load-sensing system found above. High flow at low engine speeds maintains high output with economy, as the variable flow pump only supplies oil on demand, while the full output of the large capacity pump is only put into action when required.



### Ultimate Draft Control

Massey Ferguson continues to lead the way in electronic linkage control (ELC). Massey Ferguson's digital ELC system gives the highest standards of draft control with more accurate depth settings and better ground contour following. The result is more weight transfer, better traction, less wheelslip, reduced tyre wear and reduced fuel consumption whilst still maintaining greater output.

# MF 7700 S



Conveniently located decompression levers



## Auxiliary spool valves

Between two and four electro-hydraulic valves are fitted as standard and up to five rear spool valves may be available if required. The Fingertip Spool Valve Management System enables complex equipment to be controlled with ease and precision.

- Rear lift capacity up to 9950 kg
- Optional Integrated front linkage with 4000kg lift capacity
- Up to 8 spool valves :
  - 5 rear spool valves & free return with decompression levers
  - 1 independant front linkage
  - 2 independant front spool valves & free return

## Standard Active Transport Control (ATC)

When driving across the headland or transporting heavy mounted equipment, implement 'bounce' can occur.

Active Transport Control is a shock-absorbing system which minimises the 'pitching' action – automatically adjusting for different implement weights.

This gives smoother, safer, faster transport and, by reducing shock loads through the lift rams and hydraulic circuits, also minimises the risk of damage to the rear linkage and the implement.

## ATC and Suspended front axle

ATC operates in addition to the Massey Ferguson-designed suspended front axle to give exceptional stability when transporting or operating mounted equipment at speed, giving greater comfort, safety and productivity.

## Power Beyond

Built into the CCLS spool block is a Power Beyond facility that via additional flow and return pipes provides oil flow directly from the pump enabling additional remote spool valves to be connected.

MF 7700 S		Open centre system			Closed centre system		
		Transmission	58 l/min	100 l/min	110 l/min	150 l/min	190 l/min
Model	Dyna-4 and Dyna-6	●	○	○	-	-	
MF 7714 S to MF 7718 S	Dyna-6	-	-	●	○	-	
MF 7718 S to MF 7726 S	Dyna-VT	-	-	●	-	○	
MF 7700 S							

- Not available ● Standard specification ○ Optional

Highlights

# Outstanding operation and performance to tackle any task - power take off

The MF 7700 S is a tractor which is powerful, full of torque and nimble capabilities. Perfect if you are looking for a machine with unbeatable power take off for outstanding operation and performance when working with the most advanced implements.

## PTO options for every application

A wide choice of PTO options are available with standard PTO speeds at 2,000 rpm, where maximum power is achieved. With the benefit of a 'constant power' band of up to 1500 rpm and the ability to precisely select any ground speed at the chosen engine speed, you can always achieve a perfect match of PTO speed, forward speed and power – with optimum economy.

MF 7700 S Efficient and Exclusive versions are equipped with electrical PTO speed selection for convenience.

An additional fender-mounted engagement PTO start/stop button allows the PTO to be engaged from outside the cab linked to a memorised engine rpm activation. This offers a convenient and safe way to handle applications such as filling a slurry tanker where the operator needs to be outside the cab.

## Power with economy

For lighter duty work, '540 Eco' or '1000 Eco' PTO speed is achieved at around 1550 engine rpm, further improving fuel economy and helping to reduce in-cab noise levels.

## Automated PTO control

In 'Auto' mode, the PTO is automatically disengaged when the linkage is raised (or when travelling at speeds above 25 km/h) and re-engaged when the linkage is lowered.

Further reducing the need for operator input, the Transmission Controller monitors and controls PTO engagement depending on load. This gives a smoother 'take-up', for improved driver comfort and also helps to protect both implement and tractor from damage caused by inappropriate engagement.

## Front PTO (optional)

A six-spline front PTO which operates at 1,000 rpm is available on MF 7700 S tractors, and combined with the front linkage allows a wide range of additional implements to be powered, helping to reduce passes and improve efficiency. Benefit from real time savings – such as more than doubling output when mowing grass.



Command Centre PTO selector switches and Auto activation button.



Pillar mounted PTO speed selection controls and linkage controls.



**MF**technology  
CONNECTED BY FUSE

## Connected farming from Massey Ferguson

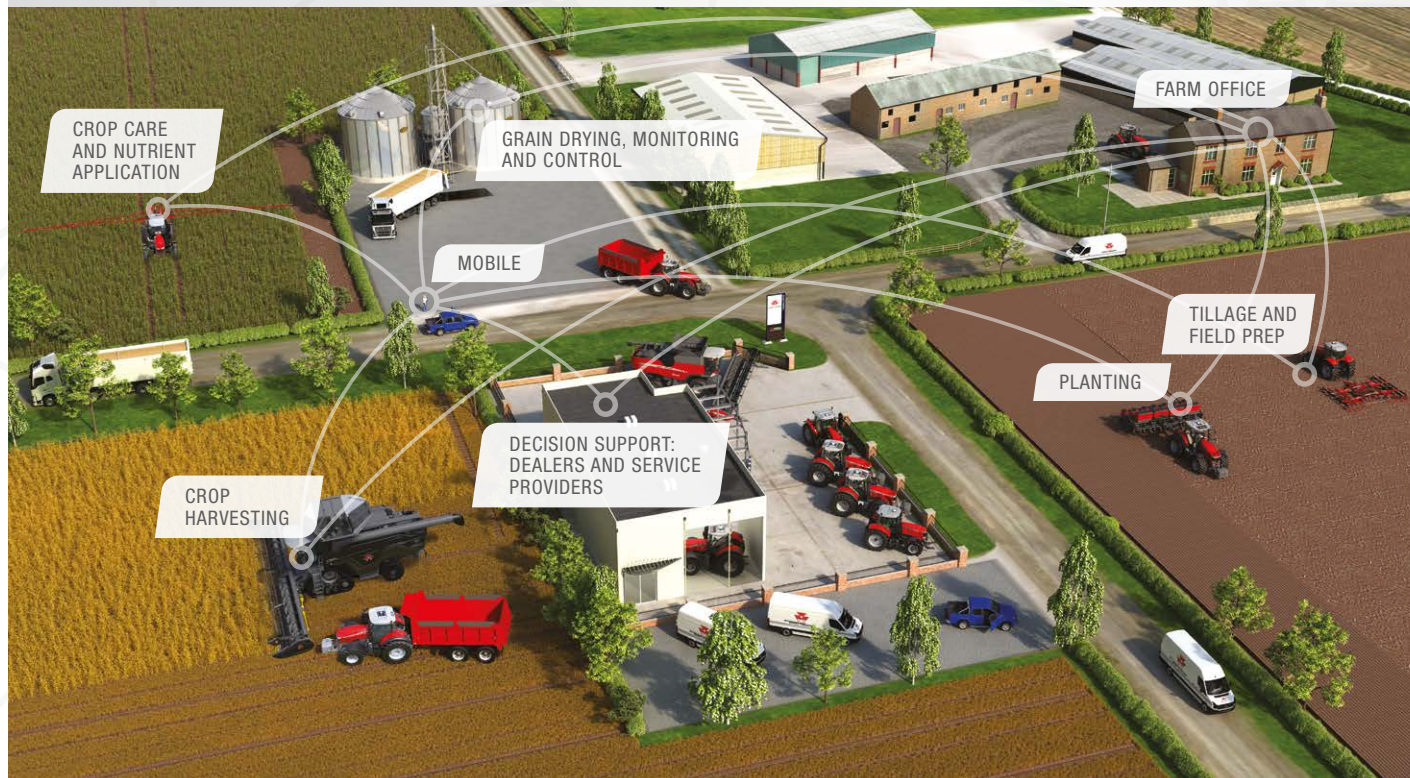

The on- and off-board technology solutions incorporated into the MF 7700 S Series are a clear indication of the pace of progress and innovation setting by Massey Ferguson. Information is power when it comes to get the job done more efficiently and more productively. This is the reason why Massey Ferguson delivers straightforward and dependable technology solutions resulting in unbeatable ease of use, improved productivity and profitability through higher yields, lower inputs costs and greater profits.

For more information on Fuse™ Technologies please visit:  
<http://www.agcotechnologies.com/MFEAME>



AGCO's overarching technology strategy is called Fuse™ Technologies and it will provide professional growers around the globe seamless integration and connectivity across all their farm assets. It will transform farming by delivering precision agriculture solutions that lead to reduced input costs, greater efficiency and profitability.

## The new touch of Precision Farming

### Powered by Fuse™ Technologies



1  
Auto-Guide™ is Massey Ferguson's full featured, hands free steering system, available on new tractors or as an after-market installation. Auto-Guide™ is capable of delivering sub-metre, decimetre and centimetre accuracy, increasing the efficiency of your farming operations saving time and money.



2  
Video Mode – Pictures from an on-board camera can be displayed on the console screen, allowing operators to monitor complex implements or simply improve safety and efficiency when reversing.

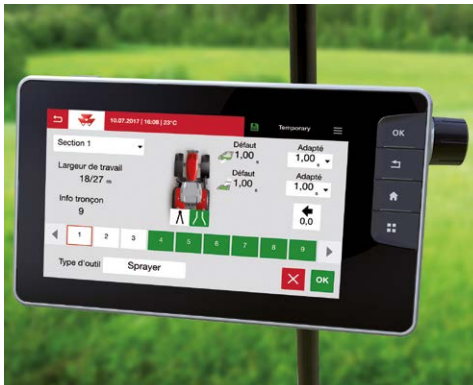

3  
AgControl™ is the new Precision Farming solution from Massey Ferguson providing with the most advanced and most efficient Section Control feature.

## Fieldstar 5

The new Fieldstar 5 terminal is designed in order to create a more intuitive Precision Farming experience, providing a system that delivers a straightforward easy to use experience, improving efficiency, productivity and profitability.



The New Fieldstar 5 features a larger 9 inch touch screen, easy-to-use and intuitive arrangement, similar to the latest generations smart-phones or tablets.

The New Fieldstar 5 and Massey Ferguson's Technology Package is a key asset for enhancing Precision Farming. Making agriculture more profitable and sustainable for the New Generation of Farmers.



4

**ISOBUS for total implement control** – ISOBUS allows an implement manufacturer's control system to be displayed on the terminal screen, saving owners and operators time and money, with no need to install additional monitors in the cab. Simply plug the implement lead into the tractor's ISOBUS socket and the system automatically uploads the operating menus and displays on the screen. MF 7700 S ISOBUS applies to the AEF (Agricultural Industry Electronic Foundation) certification.



5

**ISOBUS MultiPad switch assignment.**

ISOBUS implements can be controlled directly using the MultiPad lever. Having all controls (tractor and implement) on the same lever is a lot more convenient than using additional displays and levers. This really versatile system allows several implements to be stored to operate via MultiPad, so it can work with all ISOBUS implements currently in the farm fleet.



6

With TaskDoc™ all jobs' data can be recorded with a minimum of effort, documented in the field record and then analysed, all in the shortest amount of time.



# Guidance options to keep you on track for profit

Auto-Guide™ is Massey Ferguson's full featured, hands free steering system, available on new tractors or as an after-market installation. Auto-Guide™ is capable of delivering sub-metre, decimetre and centimetre accuracy, increasing the efficiency of your farming operations.



## Easy, fast set up with Go Mode function

Starts up within 5 minutes, even for first time users – This smart function allows the operator to begin working with auto-guidance/steering for the first time within a five-minute set-up time, making the system easy to work with and the benefits faster to reap.

This unique function allows Auto-Guide™ start-up within 5 minutes to allow even inexperienced drivers to step seamlessly into working with the system after just a few implement and wayline settings.

Implement



Wayline



Go!

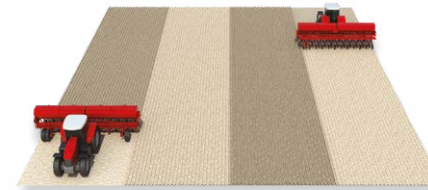

**Virtually eliminates overlaps** increasing field area covered per hour

Guidance systems are proven to **save up to 12% fuel** in field operations



More efficient working means **less tedium, stress and fatigue for the operator** and more time to optimise performance of the machine

You choose the level of accuracy you need to fit your requirements

**Submetre Accuracy**

TERRASTAR L, EGNOS, WAAS, Autonomous, RangePoint RTX.

**Decimetre Accuracy**

TERRASTAR C, CenterPoint RTX Standard.

**Centimetre Accuracy**

NTRIP (3G), Satel UHF 400 Mhz (Option), CenterPoint RTX FAST US and EU (Satellite), Hiper AG with, Local solution.



You choose your receiver according to the accuracy you are looking for

With the new Massey Ferguson Auto-Guide™, there are now two different receiver systems available, NovAtel® and Trimble®. Existing Trimble® RTK infrastructures on the farm, such as NTRIP, can continue to be used. A number of correction signals are supported, depending on the receiver, for example, EGNOS/WAAS or RangePoint RTX™, CenterPoint RTX™ and NTRIP. Talk to your local Massey Ferguson Dealer or Distributor to find out more.

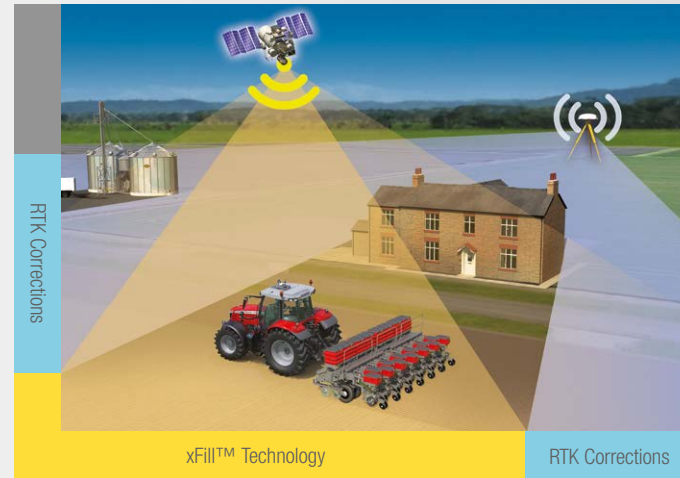

Should you lose your signal due to the terrain, Auto-Guide™ continues to work reliably up to 20 minutes without a correction signal thanks to Trimble®-xFill™ technology.

# AGCONTROL™

AgControl™ is the new Precision Farming solution from Massey Ferguson providing with the most advanced and most efficient Section Control feature. With the fully automatic Section Control for ISOBUS implements, operators can apply seeds, fertilizer or pesticides without overlapping. This prevents double treatment and areas worked outside of the field edges. With the aid of the straightforward and easy to use Section Control assistant, the operators can set the correction values for each implement, quickly and easily. The system uses the tractor's GPS system to automatically turn on and off individual sections in areas that have already been covered which automatically results in economical application and enhanced yields.

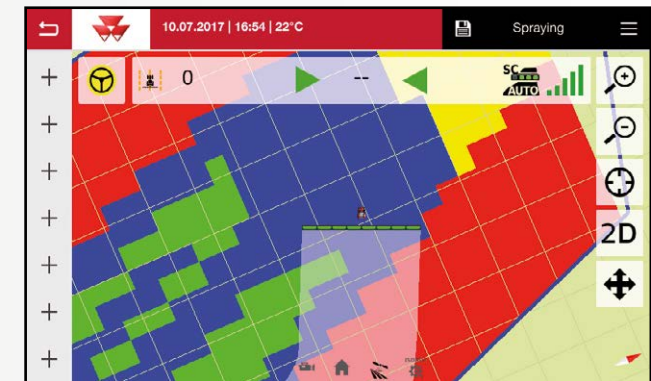
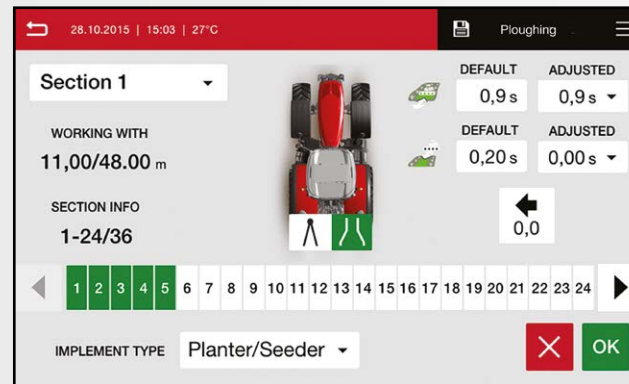

## Variable application with VariableRateControl (VRC)

Data transfer with TaskDoc™ Pro now permits variable rate application, based on the needs of the soil or plants, and therefore saves operating inputs. The individual requirements for seeds, fertiliser and pesticides are shown on application maps. They are then called up during operation and automatically executed. The big advantage: operating inputs can be defined and planned with the aid of the field database and then applied with utmost precision. For example, you can tailor chemical or fertiliser application in areas as required, lowering input cost and further enhancing yields.



Information is power, with accurate data measurement and recording enabling more precision in decision making. The pace of progress and innovation set by the MF 7700 S series is evident in the on-board technology solutions that it incorporates.

The new TaskDoc™ system has a real place in the future of agriculture, helping farmers to become more productive through the knowledge brought by putting precision-measured data at the business owner's fingertips.

With **TaskDoc™** all jobs' data can be recorded with a minimum of effort, documented in the field record and then analysed, all in the shortest amount of time. The data is transferred wirelessly from the Fieldstar 5 terminal to the field database using the ISOBUS standard TC-BAS. Data on the quantity of seeds and fertiliser applied or the fuel consumption is available immediately after the work is done.

The **TaskDoc™ Pro version** also enables recording of the GPS position data and data transfer in real-time. This makes automatic, seamless exchange with ISOXML-capable field management software and mapping possible. The data for the operating inputs that have been used are transferred and can also be monitored through the Fieldstar 5 terminal while working.

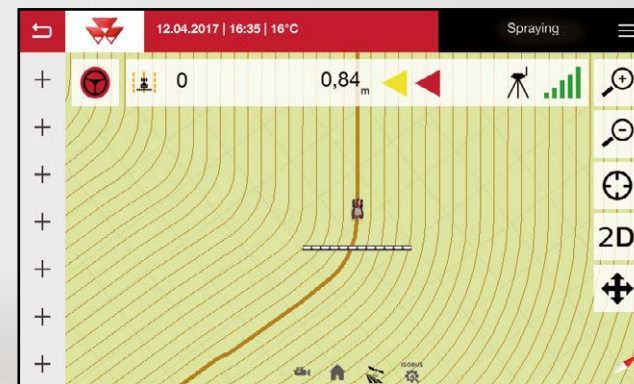
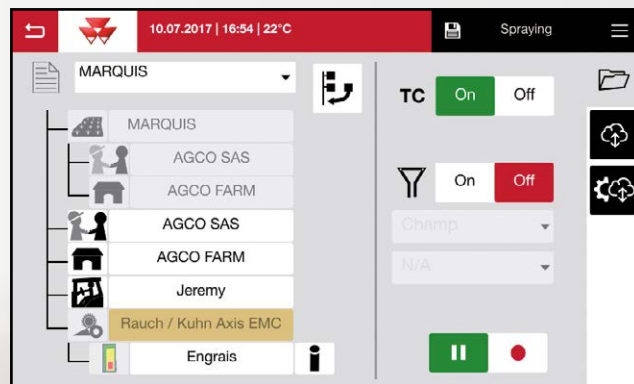

# The Datatronic 4.

## Keeping you informed and in control



Fitted as standard on MF 7700 S Exclusive models, and available as an option on Efficient models, the Datatronic 4 console puts information at your fingertips to allow you to quickly make the best decisions to run your business efficiently.



1

**Full tractor functions management** and optimisation features such as transmission, engine and hydraulics. Moreover there is the remarkable Dual Control system providing excellent control of semi-mounted ploughs by automating the furrow entry and exit. At the same time the system adjusts the plough's depth wheel in relation to the rear linkage. The same system is also used to control implements on the front linkage, automating depth settings and the entire operation, in synchronisation with the rear linkage.

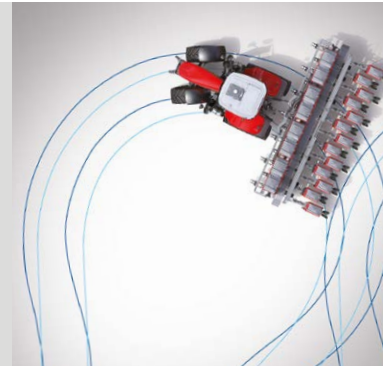

3

**Headland management settings** – The Datatronic 4 comes as standard with the most intuitive, straightforward and easy to use automatic headland management system available in the market today and developed exclusively by Massey Ferguson. It is designed to save you significant time at headlands, allowing you to concentrate on the operation in hand so that you can maximise outputs with ease.



2

**Video Mode** – Pictures from an on-board camera can be displayed on the console screen, allowing operators to monitor complex implements or simply improve safety and efficiency when reversing.



4

**Memorise data and settings** – Up to eight different memories enable the system to record information during operation on area worked, fuel use, hours worked and much more. All the settings and parameters can be stored by the Datatronic 4. Securely back-up those tractor settings: A truly unique feature of Datatronic 4 is the ability to save the memorised tractor settings to a USB memory stick and manage those settings before commencing work. All these settings can be transferred between all your machines equipped with Datatronic 4.





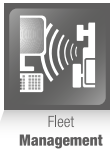

## Greater uptime, optimized maintenance and smarter services with Massey Ferguson Connected Services & AgCommand®

Connected technologies offered by the new AgCommand® telemetry solution enable your Massey Ferguson Dealer to help you manage your equipment to maximize uptime and productivity, while reducing operating costs. That leaves you totally free to focus on improving your farm business.

MF Connected Services is a collection of intuitive technology features and best-in-class dealer support that make your life as an MF Customer easy, more profitable and efficient: from remembering to book a due service interval, to planning preventative maintenance to avoid any downtime when you need the job done, to monitoring your machine and fleet performance.

**With Massey Ferguson Connected Services, AgCommand® and your MF Dealer, you can rest assured you are in good hands.**

Through on-board sensors and GPS location, up to 40 parameters, depending on your contract subscription, of your MF 7700 S are transferred to a central and secured MF server, from where it can be accessed over the internet from any web browser on your farm computer, your tablet or your smartphone. If you allow, your local MF Dealer can access and evaluate this data, and so effectively provide you with the accurate support for :



### Greater Uptime

Machine service and maintenance alerts so that you and your dealer can effectively prepare for your tractor's visit to the workshop, before contacting you to make an appointment. Having to remember when your MF service is due becomes a thing of the past.

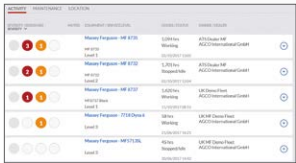

### Optimized maintenance

Critical machine alerts such as high coolant temperature or engine oil pressure will allow preventative maintenance avoiding any potential breakdown and downtime. Real time monitoring of machine parameters and GPS location helps plan maintenance.



### Optimized Performance

Your dashboard provides you with full machine efficiency report to ensure you are getting the best return on investment. For example information on the fuel consumption and idle time monitoring can help drive down your costs.

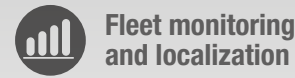
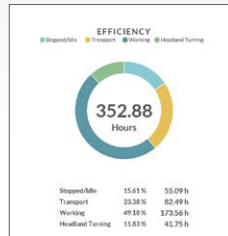

### Fleet monitoring and localization

With MF Connected Services you can easily monitor your fleet, know where your machines are, their live performance in the fields. Thanks to the geofencing feature you can also receive alerts when your machine is leaving a predefined area. It can also, for example, send a message to alert you when an operator is returning to the farm or if he requires fuel in the field.

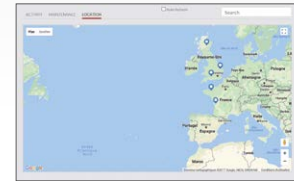

### Offered as an option the MF Connected Services from AgCommand® allows you to choose:

**1.** The level of information you want to monitor from the basic to the more advanced solution

**2.** The number of hours of work and years you want to cover with your AgCommand™ subscription

**3.** Data accessibility to your local MF Dealer to benefit from their full support and only have to focus on your farm business

Please visit your MF local Dealer should you need more information.

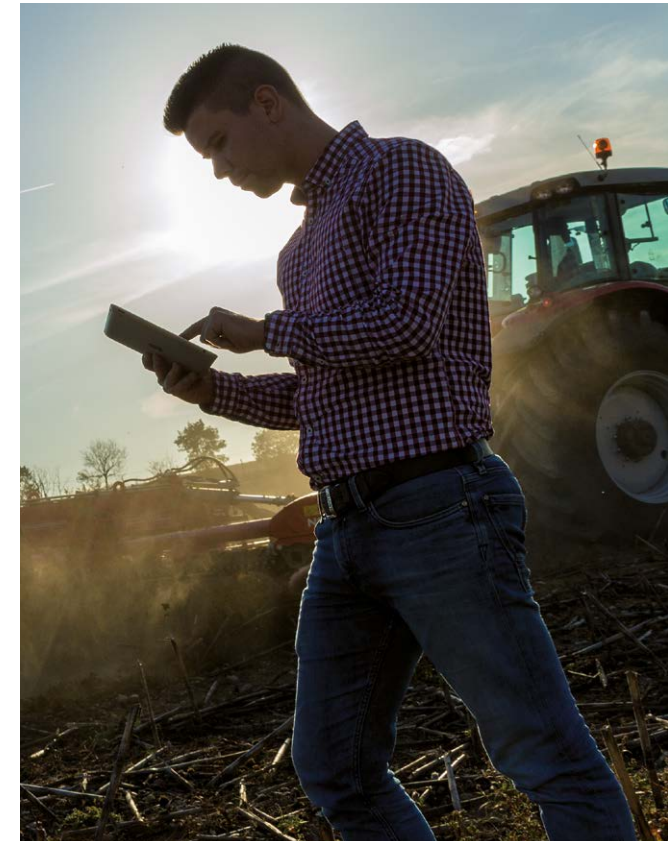

## Servicing made easy

Right from the first drawing, the MF 7700 S has been designed to provide fast, straightforward, easy and cost-effective routine maintenance. Servicing is straightforward and simple, taking the stress out of maintaining your tractor and leaving you with more time in the field/at work. With 600 hours service intervals, maintenance costs are substantially reduced. With a Massey Ferguson MF 7700 S series tractor, time spent in the yard preparing for the day ahead is kept to a minimum. We have combined practicality with style to ensure daily maintenance is speedy, straightforward and simple, taking the stress out of maintaining your tractor, getting you to the field earlier for greater productivity.

Easy access to remove the cab air filter for cleaning.



Front axle and slim waist bonnet design make oil dipstick and filter access easy.



Engine air filter is easy to access and clean. Up to 90% of dust is removed by the suction system from the exhaust gas.



Radiators clearance for cleaning, and can be easily accessed with an air line.



Total Customer  
peace of mind

# MFservices

Combined services to increase our customers' profit and efficiency

Welcome to MF Services – everything you need to support the operation of your Massey Ferguson machine.

Accessible and adaptable, MF Services will help you control running costs, budgeting and business planning - ensuring each machine operating hour is a success and giving you the freedom to focus fully on the core business of farming.

This comprehensive suite of service-related-products makes it easier than ever to own and operate MF farm equipment.

Covering finance, extended warranties and servicing, telematics, precision farming technologies and genuine parts, MF Services is your one-stop shop for all existing and future services to keep your business on track and your equipment up and running.

Our goal is to ensure that your Massey Ferguson machinery is operationally-efficient at the highest level throughout its working life.

## MFcare provides total peace of mind

MFcare is a comprehensive, industry-leading package that provides total care of your MF 7700 S tractor providing routine maintenance, repairs and a full AGCO-backed warranty, which includes:

- Engine and transmission
- Electronics
- Hydraulics
- Cab and controls
- PTO
- Axles
- Steering

Regular servicing in the MFcare plan provides 'preventive maintenance' – picking up any faults before they become a problem, which helps reduce downtime. A full dealer service history, using genuine AGCO Parts will also increase the residual value of the machine.

## AGCO Finance\* provides the perfect financing arrangement for your business

AGCO Finance is the integrated financial services arm of Massey Ferguson offering tailor made solution to your own farm, which includes :

- Leasing
- Loan facilities
- Hire purchase
- Full service packages
- Contract hire

\* Please contact your Massey Ferguson local dealer to check availability in your area. Terms and conditions apply that might vary according to the market or country.



Industry-leading parts supply from AGCO Parts.

# Standard and optional equipment by version

Whichever sector you're in, make the tractor your own

	Essential	Efficient	Exclusive
<b>Engine</b>			
6 cylinders AGCO POWER Stage 4	●	●	●
Selective Catalytic Reduction (SCR) technology	●	●	●
Engine speed memory (1 or 2)	●	●	●
Low idle engine speed	●	●	●
Engine block heater	○	○	○
<b>Transmission</b>			
Power Control lever	●	●	●
Right hand shuttle control	○	○	●
T lever on Control Centre	●	-	-
T lever on Command Control Armrest	-	●	-
MultiPad lever on Command Control Armrest	-	○	●
Dyna-4 - 40Km/h Eco - Speedmatching & Autodrive	●	-	-
Dyna-6 - 40Km/h Eco <sup>2</sup> - Speedmatching & Autodrive	●	●	●
Dyna-6 - 40Km/h Super Eco <sup>3</sup> - Speedmatching & Autodrive	●	●	●
Dyna-6 - 50Km/h* Eco - Speedmatching & Autodrive	○	○	○
Dyna-VT 40km/h Super Eco with Dynamic Tractor Management (DTM)	-	●	●
Dyna-VT 50km/h* Eco with Dynamic Tractor Management (DTM)	○	○	○
Supercreeper <sup>2</sup> or creeper <sup>3</sup>	○	○	○
Cruise speed memories	-	●	●
Brake to neutral - Clutch effect	●	●	●
ParkLock <sup>3</sup>	-	○	○
<b>Operator Environment</b>			
2 opening doors	●	●	●
Panoramic cab with polycarbon right-hand side window	○	-	-
Standard air conditioning with manual adjustment	●	●	-
Automatic air conditioning / climate control	-	○	●
Visio roof <sup>2</sup>	○	○	○
Roof hatch	○	○	○
Air suspended swivel seat <sup>2</sup>	●	-	-
Automatic air suspended swivel seat	○ <sup>2</sup> /● <sup>3</sup>	●	-
Super deluxe air suspended seat with heater & pneumatic lumbar adjustment	-	○	●
Auxiliary seat with seatbelt	●	●	●
Mechanical cab suspension	○	●	-
Active mechanical cab suspension	-	○	●
Radio - MP3 - SD card slot - USB	○	●	●
FM or DAB + (Digital) Radio, CD, MP3, Bluetooth connexion, USB & front auxiliary	-	○	○
Telescopic double Angle Mirrors with Electric Adjustment and de-icing	-	○	●
Speedsteer	-	○	○
Fieldstar 5 - 9" touchscreen	○	○	○
Radar and slip control	○	○	●
Datatronic 4 with video capability	-	○	●
Trailer steering axle management	-	○	●
Dual Control	-	○	●
Quick headland management	●	●	●

- Not available

● Standard specification

○ Optional

\* Depending on market legislation

<sup>2</sup> MF7714 S to MF7718 S

<sup>3</sup> MF7720 S to MF7726 S

	Essential	Efficient	Exclusive
<b>Operator environment</b>			
Headland Management System	-	○	●
<b>Technology</b>			
ISOBUS capability & connector	○	○	○
MultiPad with ISOBUS implement control switch assignment	-	○	○
Auto-Guide™ Ready	○	○	○
Auto-Guide™ - Novatel - Submetre	○	○	○
Auto-Guide™ - Novatel - Centimetre	○	○	○
Auto-Guide™ - Trimble - Submetre	○	○	○
Auto-Guide™ - Trimble - Centimetre	○	○	○
AgControl™ 24 section control	○	○	○
AgControl™ - Variable Rate Control	○	○	○
Agcommand™	○	○	●
<b>Chassis and Hydraulics</b>			
Mechanical controls of spoolvalves	●	-	-
Electrical and mechanical controls of spoolvalves	-	●	-
Electrical controls of spoolvalves	-	○	●
Multifunction joystick	-	○	○
Loader ready tractor with Multifunction joystick (mechanical control)	○ <sup>2</sup>	-	-
Loader ready tractor with Multifunction joystick (electrical control)	-	○	○
Loader live 3rd control with Multifunction joystick (electrical control)	-	○	○
Power beyond with couplers	○	○	●
Electronic linkage controls with Active Transport Control	●	●	●
Auto PTO function	●	●	●
Electric PTO speed selection	-	●	●
Auto 4-Wheel-Drive and Auto DiffLock functions	●	●	●
Telescopic stabilisers	●	●	●
Automatic stabilisers	○	○	○
Hydraulic top link on rear three point linkage	○	○	○
Integrated front linkage system	○	○	○
Integrated Front PTO	○	○	○
<b>Electrical Equipment</b>			
Automatic isolator switch	●	●	●
ISO 11786 signal connector	-	●	●
External lift control on fenders	●	●	●
External PTO start/stop control on fender	●	●	●
External remote valve control on fender	-	●	●
16 LED working lights (12 LED lights with Visio roof) <sup>2</sup> - Day time running LED	○	○	○
<b>Other equipment (Specifications may vary by market)</b>			
Quadlink - Suspended front axle	○	●	●
Pivoting front fenders	○	○	●
Additional heater in cab	○	○	○
Pneumatic trailer brake*	●	●	●
Hydraulic and Pneumatic trailer brake*	○	○	○
ABS socket dedicated to trailer brakes	○	○	○

Every effort has been made to ensure that the information contained in this publication is as accurate and current as possible. However, inaccuracies, errors or omissions may occur and details of the specifications may be changed at any time without notice. Therefore, all specifications should be confirmed with your Massey Ferguson Dealer or Distributor prior to any purchase.

# Specifications

	MF 7714 S	MF 7715 S	MF 7716 S	MF 7718 S	MF 7720 S	MF 7722 S	MF 7724 S	MF 7726 S
<b>Engine</b>								
Engine Type	AGCO POWER							
Number of cylinders/Number of valves/Capacity	No. /No./cm <sup>3</sup>				6 / 4 / 6600		6 / 4 / 7400	
Bore / Stroke	/mm		108/120				108/134	
Aspiration	Turbo with electrical wastegate and intercooler							
Injection type	Common rail							
Fan type - Transmission Dyna-4	Viscostatic		Viscostatic					
Fan type - Transmission Dyna-6 & Dyna-VT			Vistronic		Vistronic		Vistronic	
Maximum hp	⊕ ISO hp (kW)		140 (103)		150 (110)		160 (118)	
Engine rpm at maximum hp	rpm				1950			
Maximum torque @ 1500 rpm	⊕ Nm		660		677		725	
Maximum power with EPM	hp (kW)		165 (121)		175 (129)		185 (136)	
Maximum torque with EPM @ 1500 rpm	Nm		687		745		790	
Max. power available @ PTO shaft (OECD, accuracy +/- 3%)	hp (kW)		120 (88)		135 (99)		140 (103)	
Fuel tank capacity	Litres		310		310		310	
AdBlue® tank capacity	Litres		30		30		30	
<b>Transmission Dyna-4</b>								
Number of gears	Fwd x Rev		16 x 16		16 x 16		-	
Min. speed @ 1400 rpm	km/h		1.3		1.3		-	
Number of speeds with supercreeper	Fwd x Rev		32 x 32		32 x 32		-	
Min. speed @ 1400 rpm with supercreeper	km/h		0.09		0.09		-	
40 km/h at engine speed	rpm		1900 with 520/85R38 tyres		-		-	
<b>Transmission Dyna-6</b>								
Number of gears (Fwd x Rev)	Fwd x Rev		-		24 x 24		24 x 24	
Min. speed @ 1400 rpm	km/h		-		1.03		1.03	
Number of speeds with creeper/supercreeper	Fwd x Rev		-		- / 48 x 48		- / 48 x 48	
Min. speed with creeper/supercreeper	km/h		-		- / 0.07		- / 0.07	
40 Eco / SuperEco km/h at engine speed with Max. tyre dimension	rpm		-		1800		1500	
50 km/h* Eco at engine speed with Max. tyre dimension	rpm		-		1950		1850	
<b>Transmission Dyna-VT</b>								
Type	-		-		Stepless, Continuously variable transmission		-	
Field speed range	km/h		-		Forward : 0.03 to 28 kph - Backward : 0.03 to 16 kph		-	
Road speed range	km/h		-		Forward : 0.03 to 40 kph - Backward : 0.03 to 38 kph / Forward : 0.03 to 50 kph - Backward : 0.03 to 38 kph*		-	
<b>Rear Linkage and hydraulics</b>								
Lower links type	Cat		-		Cat 3		-	
Maximum lift capacity, at link end	kg		7100		7100/8100/9600		7100/8100/9600	
Hydraulic type & max flow	l/mn		-		Open Centre 58 (Essential)		Closed Centre Load Sensing 110	
Hydraulic type & max flow - Option 1	l/mn		-		Open Centre dual pump 100 (Essential)		-	
Hydraulic type & max flow - Option 2	l/mn		-		Closed Centre Load Sensing 110		Closed Centre Load Sensing 150 (Dyna-6)	
Hydraulic type & max flow - Option 3	l/mn		-		-		Closed Centre Load Sensing 190 (Dyna-VT)	
Maximum pressure	Bars		-		200		-	
Maximum number of rear spoolvalves			4		4/5 (Dyna-VT)		4/5 (Dyna-VT)	

\* Depending on market legislation

<b>Rear Power Take-Off</b>	
Engine speed at	540/1000
	540/540 Eco/1000/1000 Eco
	540/540 Eco/1000/1000 Eco Dyna-VT
	540/540 Eco/1000 Dyna-6
	540 Eco/1000/1000 Eco Dyna-6
Shaft diameter	
<b>Independent Front linkage and Front Power Take-Off</b>	
Lower links type	
Maximum lift capacity, at link end	
Maximum number of front spoolvalves	
Engine speed at 1000 front PTO speed	
<b>Wheels and Tyres</b> (Full range available. Please consult your Dealer)	
Front	
Rear	
<b>Weights</b> (May vary depending on configuration. Please consult your Dealer)	
Average minimum weight with no. ballast, no. accessories	
Maximum Gross vehicle weight*	

	MF 7714 S	MF 7715 S	MF 7716 S	MF 7718 S	MF 7720 S	MF 7722 S	MF 7724 S	MF 7726 S
rpm	1980 / 2030	1980 / 2030	1980 / 2030	1980 / 2030	1890 / 2000	1890 / 2000	1890 / 2000	1890 / 1930
rpm	1980 / 1530 / 2030 / 1570				-	-	-	-
rpm	-				1870 / 1500 / 1900 / 1530			
rpm	-	-	-	-	1890 / 1520 / 2000		1890 / 1520 / 1930	
rpm	-	-	-	-	1520 / 2000 / 1600		1520 / 1930 / 1600	
Inches	1 3/8" 6 & 21 splines							
Cat	Cat 3							
kg	3200	3200	3200	3200/4000	4000	4000	4000	4000
	2							
	1920	1920	1920	1920	1920	1920	1920	1920
	420/85R28	420/85R28	420/85R28	480/70R28	480/70R30	600/70R30		
	520/85R38	520/85R38	520/85R38	580/70R38	620/70R42	710/70R42 (Dyna-6)		
kg	5800	5800	5800	6300	7150	7400	7800	7800
kg	11000	12500	12500	12500	14000	14000	14000	14000

⊕ ISO 14396 - Not available \* Depending on market legislation

## Dimensions

	MF7714 S to MF7718 S		MF7720 S to MF7726 S	
	Dyna-4 Dyna-6	Dyna-VT	MF7720 S to MF7722 S Dyna-6 Dyna-VT	MF7724 S and MF7726 S Dyna-6
A	Wheelbase	m	2.88	3.00
B	Overall length from front weight frame to rear linkage arms	mm	4928	5149
B	Overall length from front linkage to rear linkage arms	mm	5604	5868
C	Height at centre of rear axle to top of cab	mm	2110	2144
D	Total height	mm	2985	3019
			3129	3179

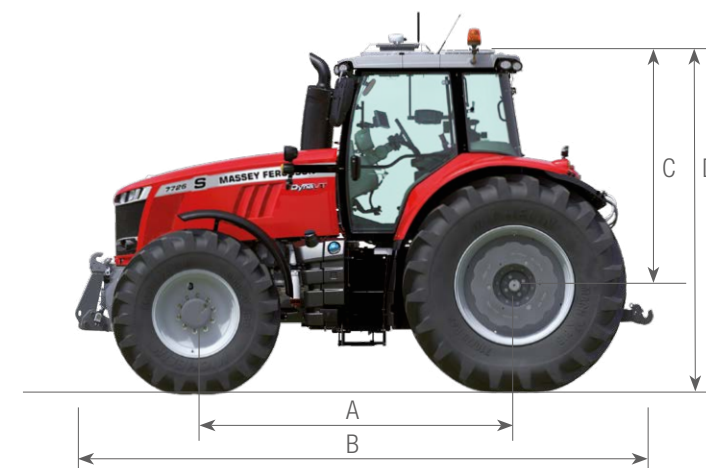

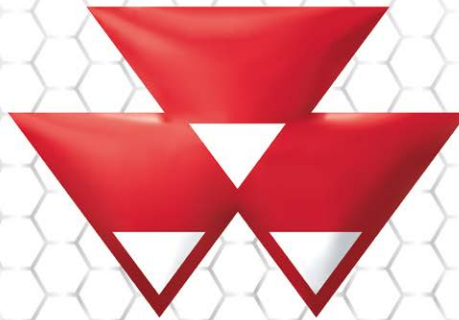

# MASSEY FERGUSON

**A world of experience. Working with you.**



Web: [www.MasseyFerguson.com](http://www.MasseyFerguson.com)

Facebook: [www.Facebook.com/MasseyFergusonGlobal](http://www.Facebook.com/MasseyFergusonGlobal)

Twitter: [Twitter.com/MF\\_EAME](https://twitter.com/MF_EAME)

Instagram: [Instagram.com/MasseyFergusonGlobal](https://www.instagram.com/MasseyFergusonGlobal)

YouTube: [www.YouTube.com/MasseyFergusonGlobal](http://www.YouTube.com/MasseyFergusonGlobal)

Blog: [Blog.MasseyFerguson.com](http://Blog.MasseyFerguson.com)



MASSEY FERGUSON® is a worldwide brand of AGCO.  
© AGCO Limited. 2017 | A-A-16459/1017 | English/1017V2



Responsible forest management

